

anex

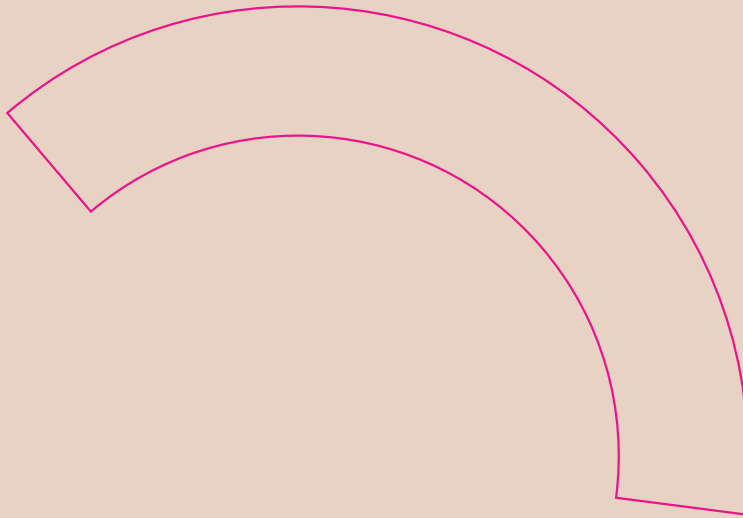

MAINTENANCE
MANUAL

eli

Effortless Style

1	Folding of the frame	5
2	Unfolding of the frame	6
3	Handle regulation	7
4	Attaching the shopping basket	8
5	Assembly and disassembly of the front wheel	9
6	Locking the front swivel wheels	10
7	Assembly and disassembly of the rear wheel	11
8	Brakes	12
9	Shock absorption	12
10	Attachment of the carrycot to the frame	13
11	Adjustment of the carrycot's hood	14
12	Ventilation of the carrycot's hood	15
13	Ventilation of the carrycot's bottom	16
14	Carrycot's foot cover	16
15	Cleaning the inside of the carrycot	16
16	Disassembly of the carrycot's hood	17
17	Attachment of the seat soft goods	18
18	Attachment of the seat unit	20
19	Folding the seat unit with the frame	21
20	Adjustment of the seat unit's hood	22
21	Ventilation of the seat unit's hood	23
22	Adjustment of the seat unit's backrest	24
23	Adjustment of the seat unit's footrest	25
24	Attachment of the seat unit's bumper	26
25	Safety belts buckle	27
26	Adjustment of the safety belts	28
27	Adapters for carrycot & seat unit	29
28	Carry handle	30
29	Mosquito net	31
30	Rain cover	31

FOLDING OF THE FRAME

1

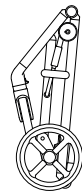
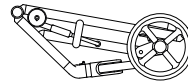
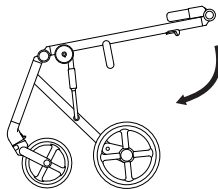
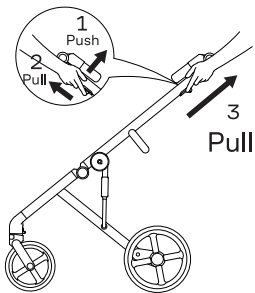
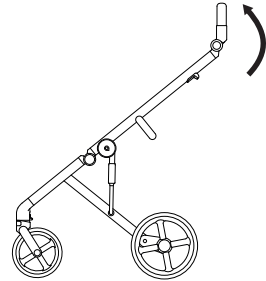
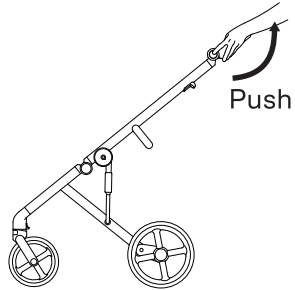
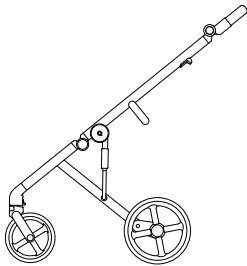

UNFOLDING OF THE FRAME

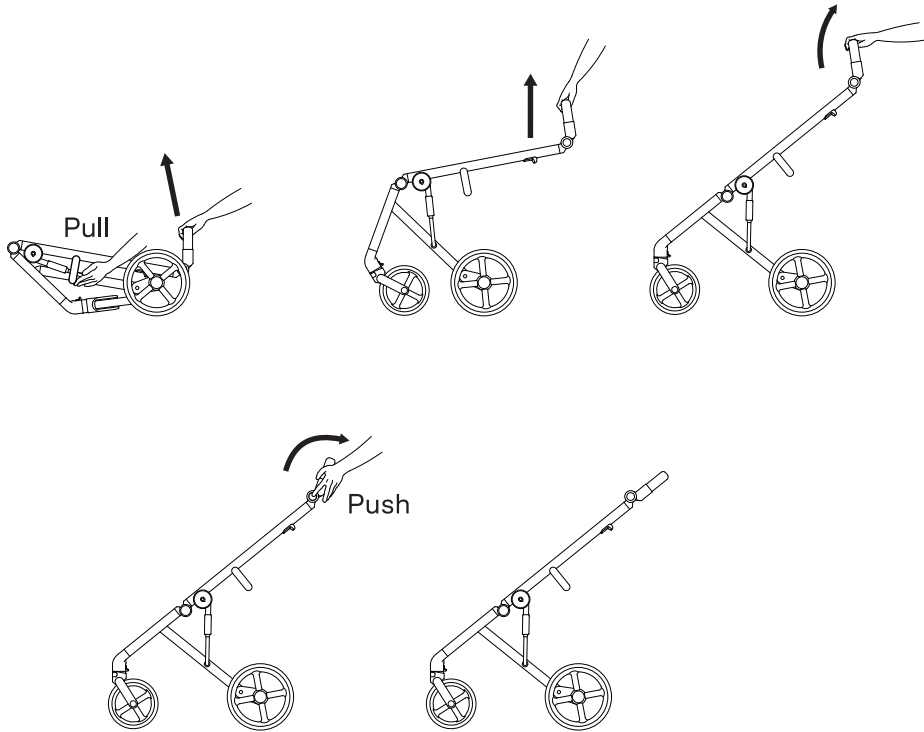

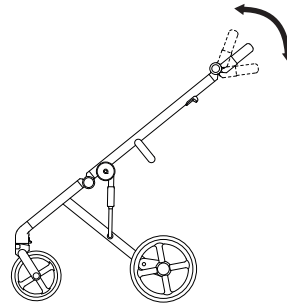
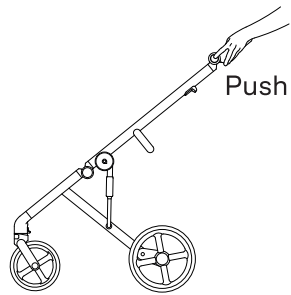

ATTACHING THE SHOPPING BASKET

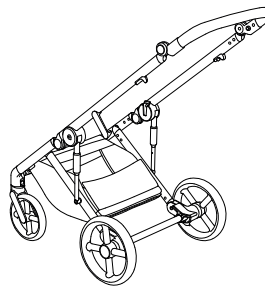
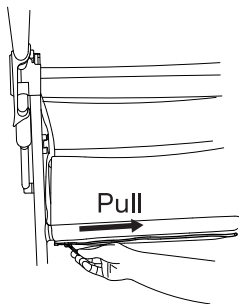
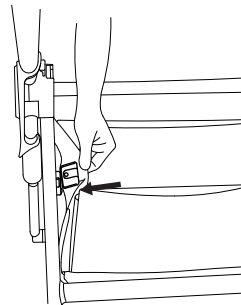
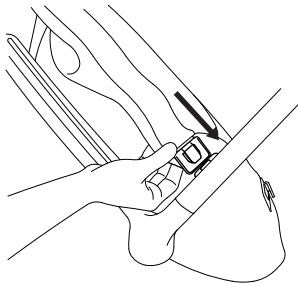

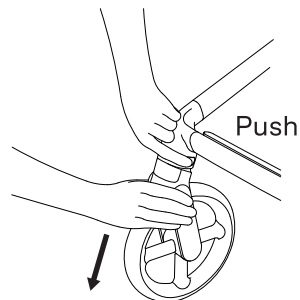
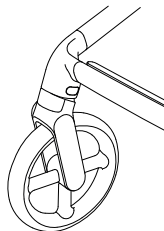
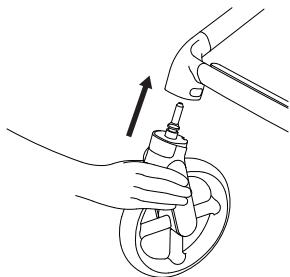

LOCKING THE FRONT SWIVEL WHEELS

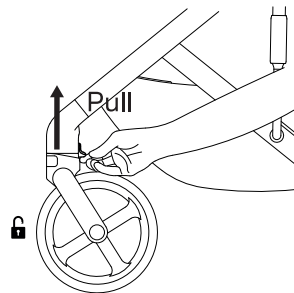
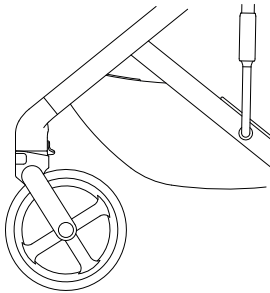
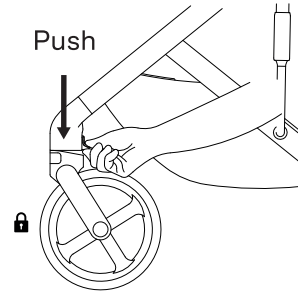
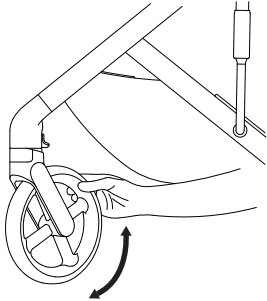

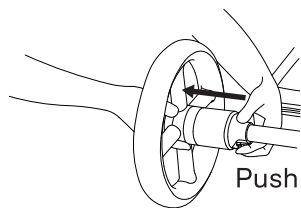
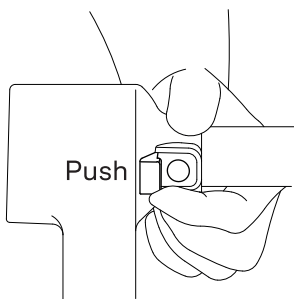
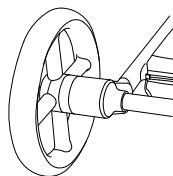
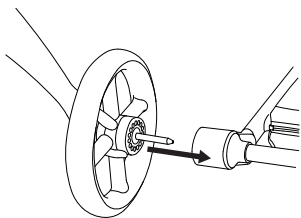

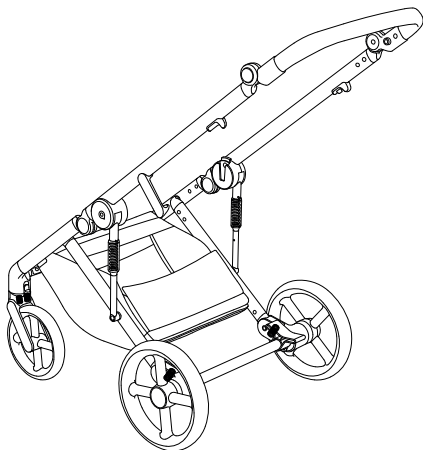
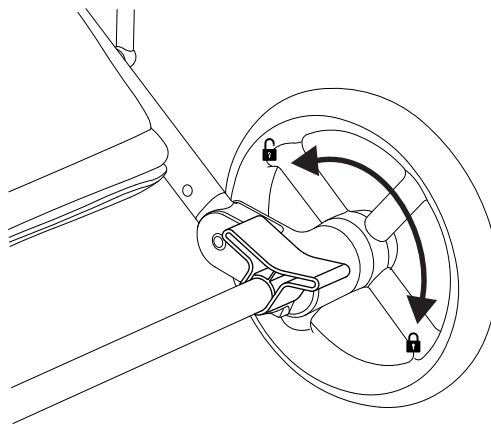

ATTACHMENT OF THE CARRYCOT TO THE FRAME

10

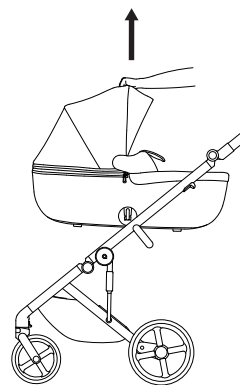
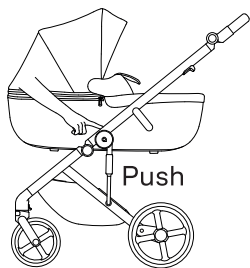
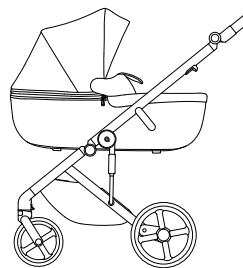
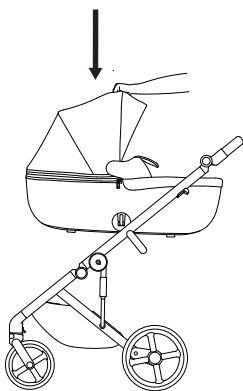

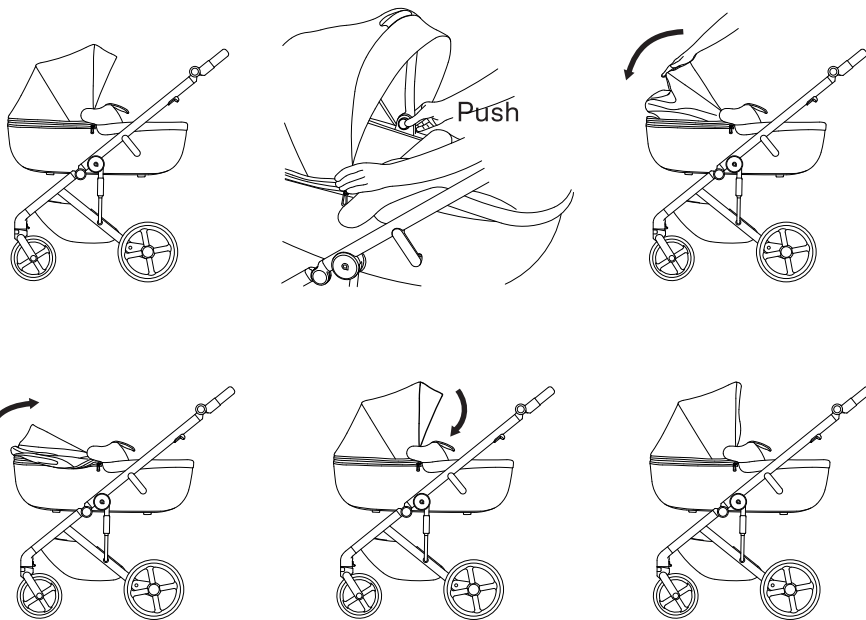

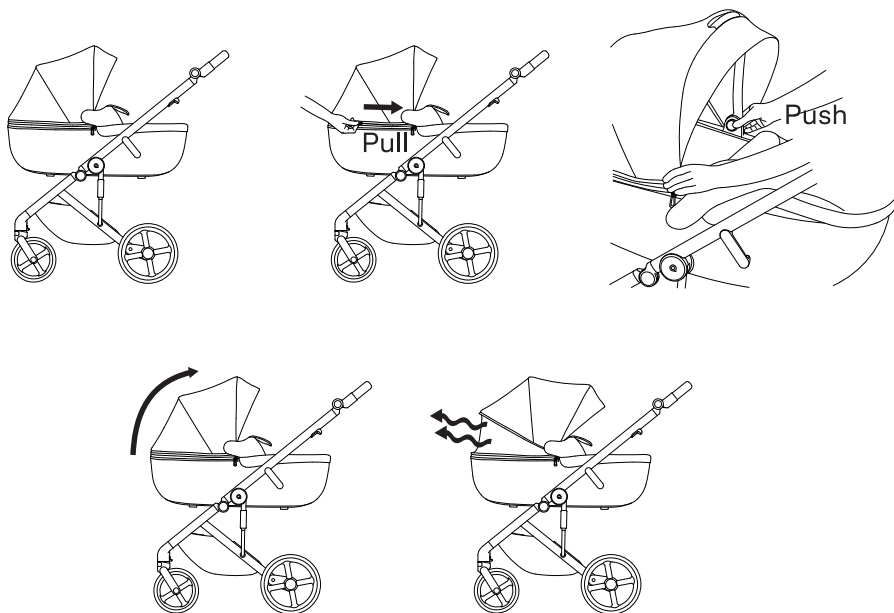

13

VENTILATION OF THE CARRYCOT'S BOTTOM

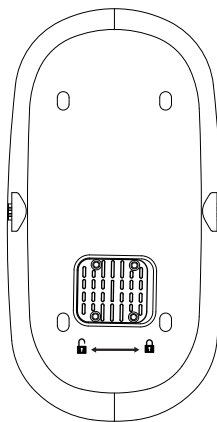

14

CARRYCOT'S FOOT COVER

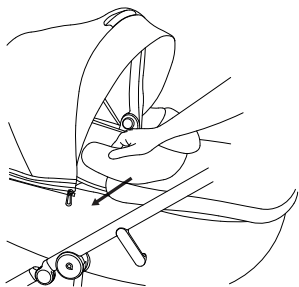

CLEANING THE INSIDE OF THE CARRYCOT

15

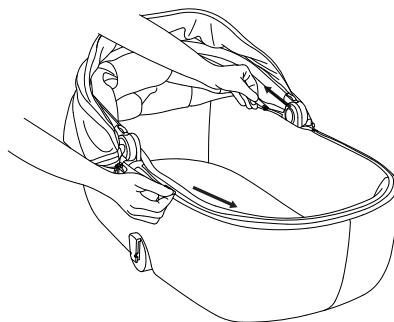

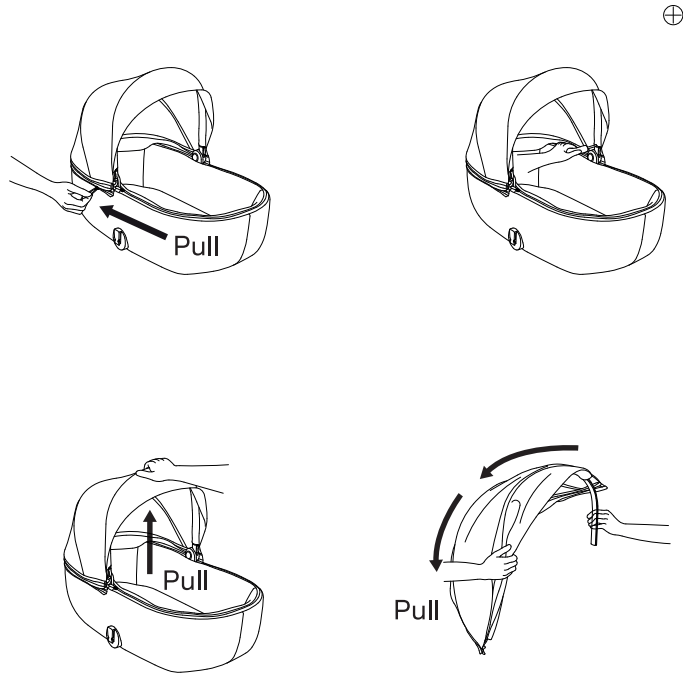

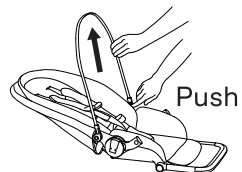
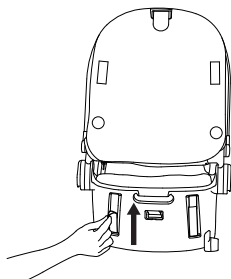
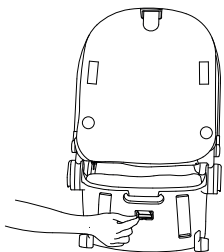
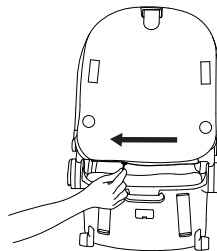
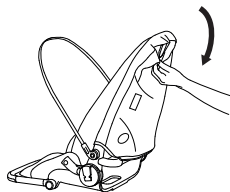
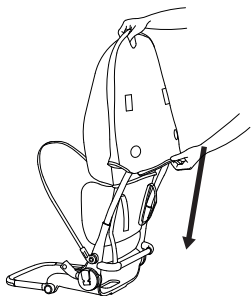

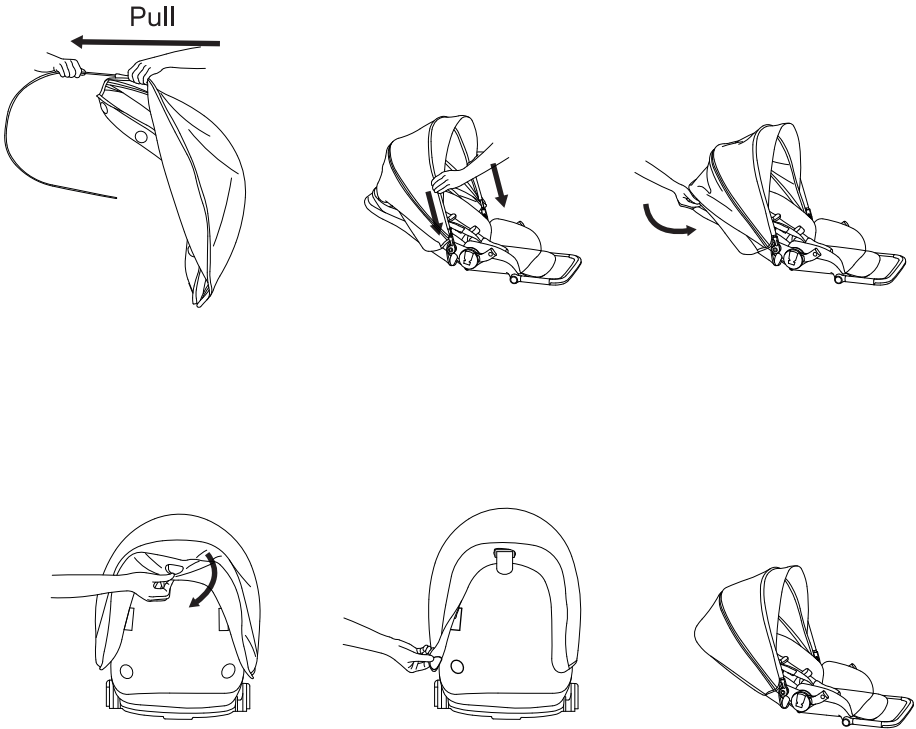

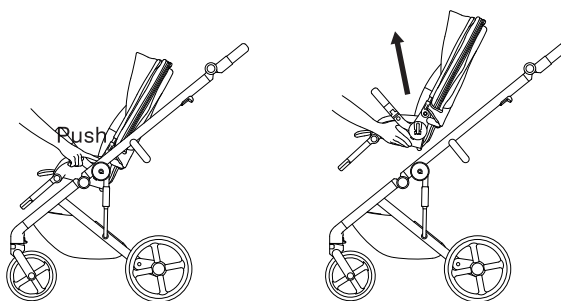

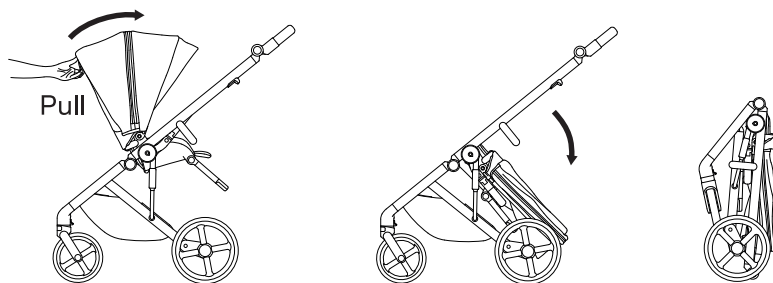
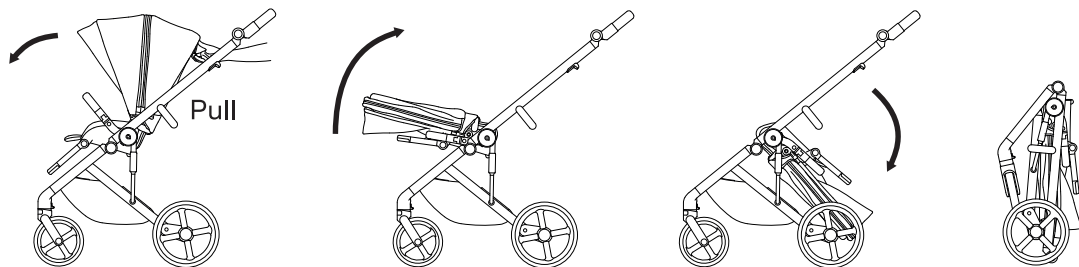

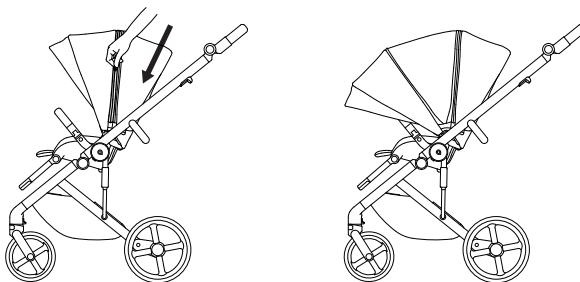

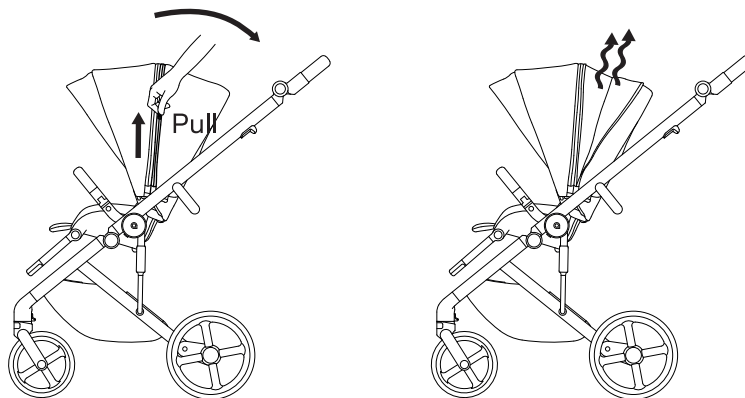

ADJUSTMENT OF THE SEAT UNIT'S BACKREST

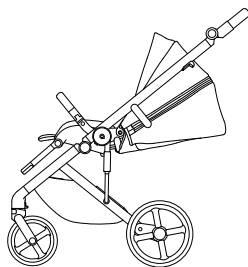
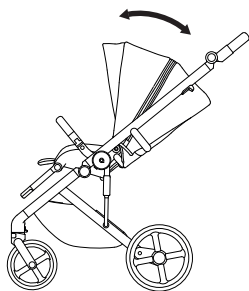
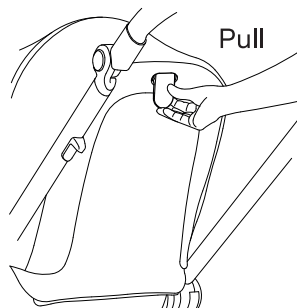
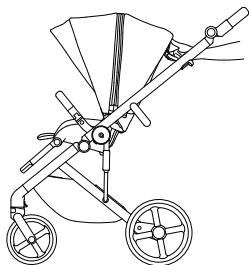

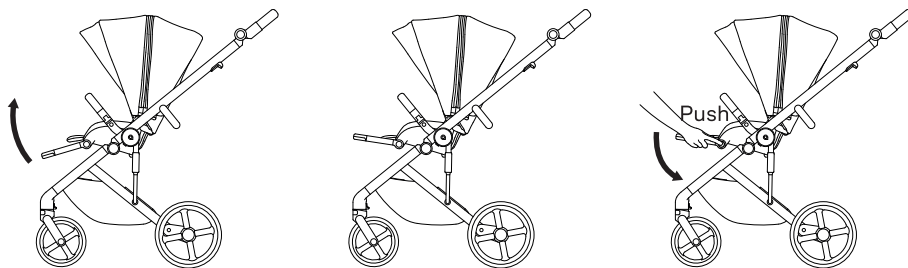
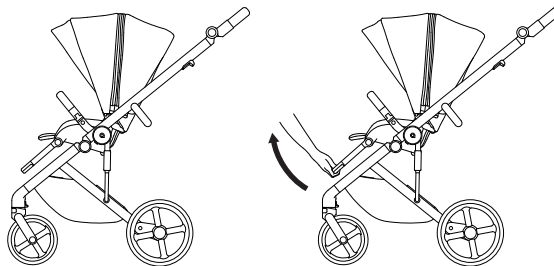

ATTACHMENT OF THE SEAT UNIT'S BUMPER

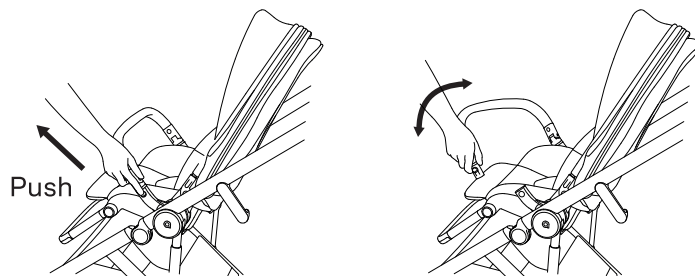
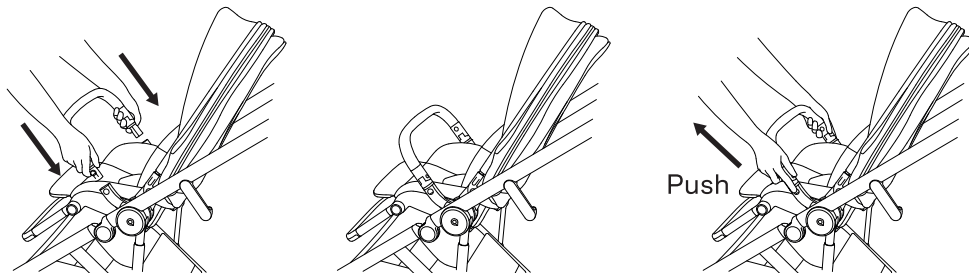

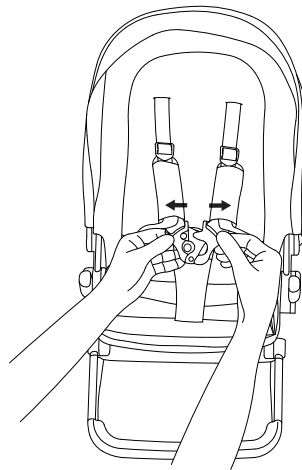
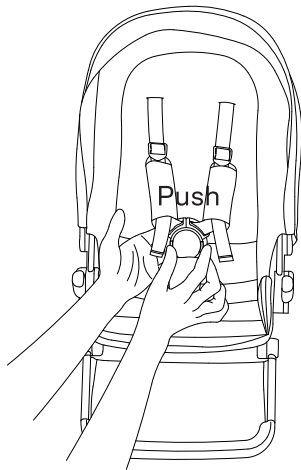

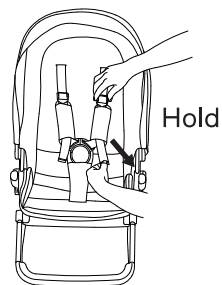
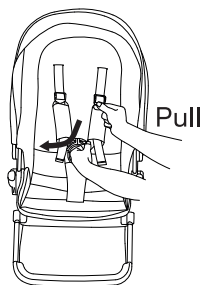
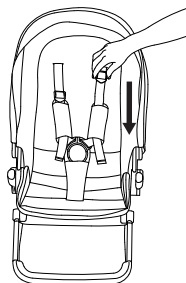
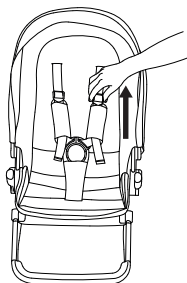

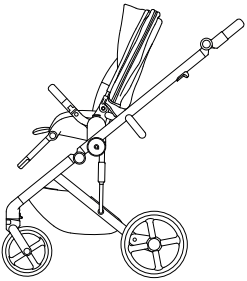
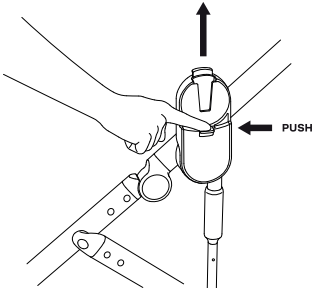
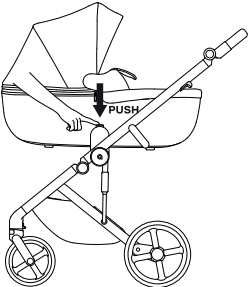
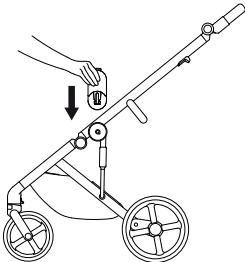

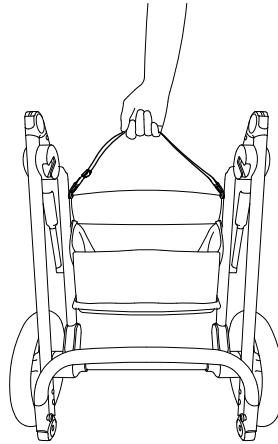
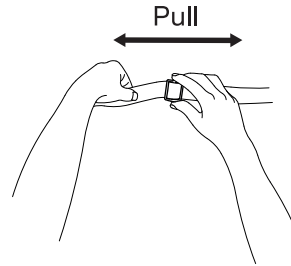
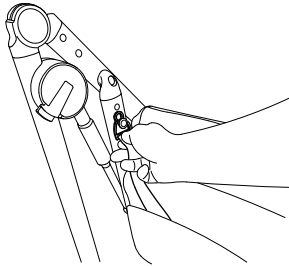

MOSQUITO NET

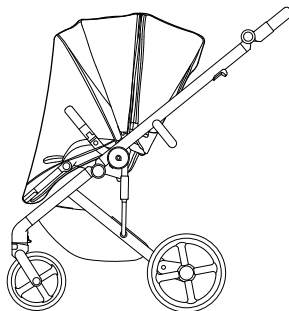
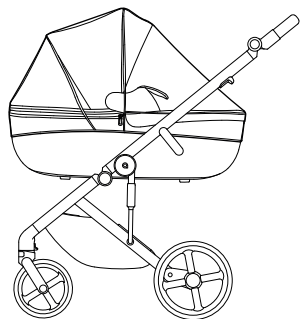

RAIN COVER

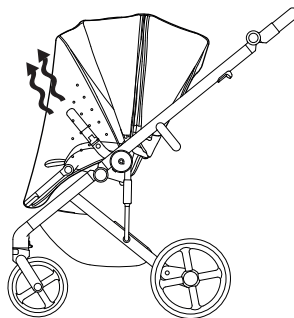
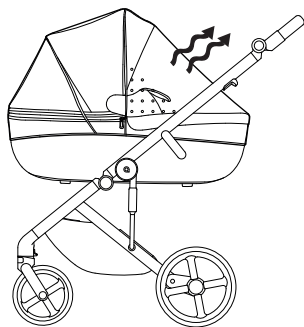

Check for the most recent manuals
on our website: **anexbaby.com**

The information is subject to change without notice.
Anex shall not be liable for technical errors or omissions
contained in this manual. The purchased product may
differ from the product as described in this manual.

AVALEX PTE. LTD.

114 Lavender Street, #08 – 58/59
CT Hub 2, Singapore 338729
tel.: +65 6221 5096

office@anexbaby.com

